

ART
MAT
RIX

I-BEAM
The Structural Series





THE STRUCTURAL SERIES

Buildings architectural lines are now held and prop-up by steel reinforced bars and beams. Our design team has been inspired by such design flow and similarly so aptly named as "I-BEAM" the new addition to Artmatrix aluminum leg structures. As the name implies, "I-BEAM" cross-sectional profile is adapted in our new leg. It resonates the robust strong thick lines of steel structures evident in factories and warehouses today. "I-BEAM" hold-up our communication flow with the current Generation-Y whose platform of growth has been vastly influenced by the X-boxes and Playstations. They themselves are familiar with such rustic steel formations and such emotions are now profoundly evident when I-BEAMs were used to float the work pieces.

I-BEAM is an open plan system which features with fully aluminium die-cast leg with chamfered groove to emphasize its masculinity and structural strength. The post and beam element of building architecture applies to I-BEAM understructure helps to present a structural framework in the workstation. This system can be combined with any extra accessories such as screen panels, pedestals and cabinets.

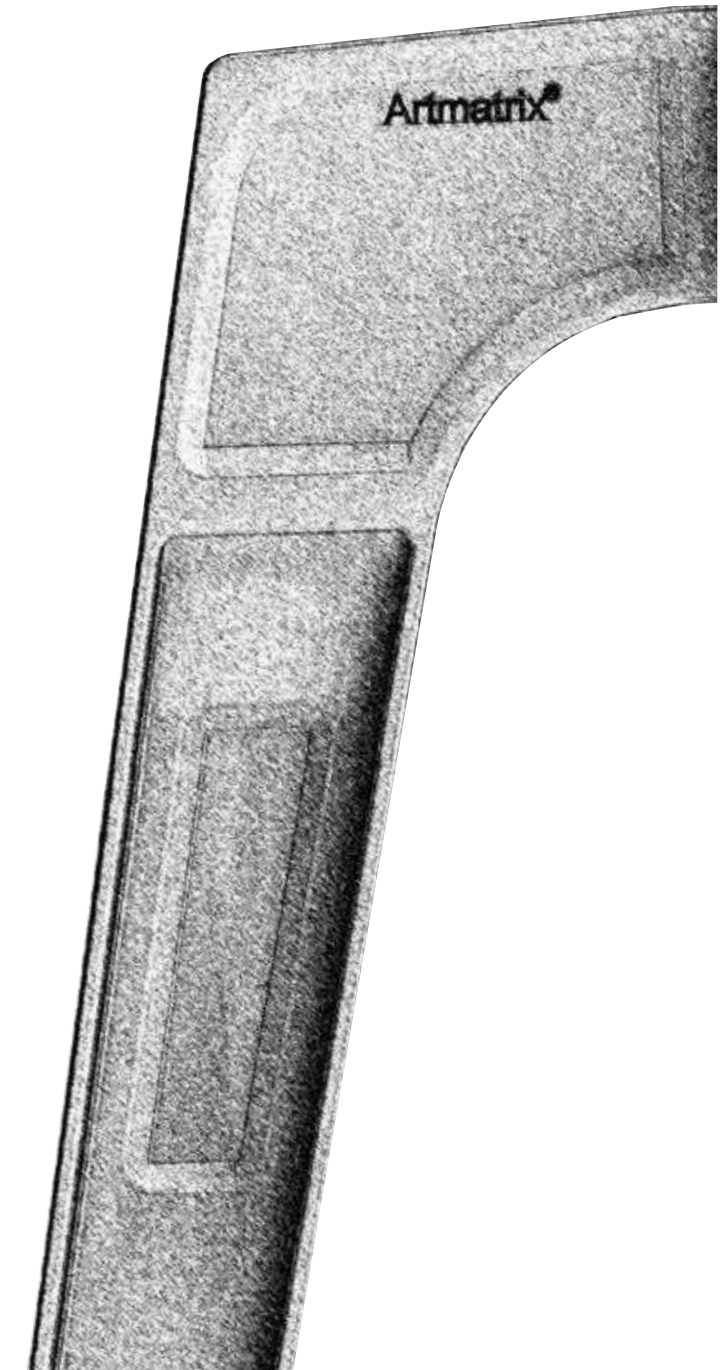



I-BEAM UNDERSTRUCTURE

Framework of I-Beam system is presented in aluminium die-cast leg and metal table beam. It uses bolt and nut with connector brackets in the framework for your convenience in configuring the workstation in any shape such as linear, L-shaped, 120 degree and even in cluster design in the workplace.

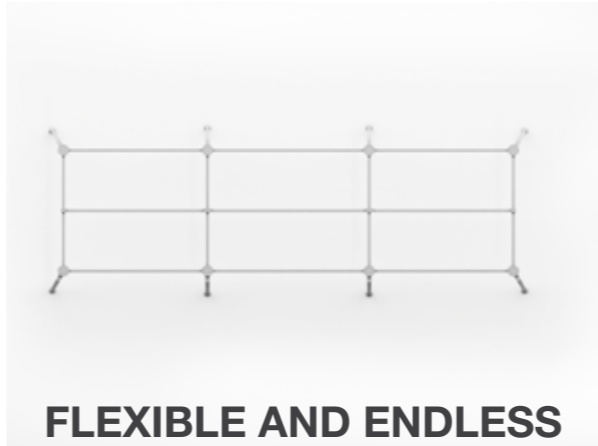

FLEXIBLE AND ENDLESS POSSIBILITIES

I-BEAM provides endless possibilities and design freedom with our approach creates flexible solutions that change with a customer's organizational needs over time. With I-BEAM, change is no longer costly. I-BEAM enables change to be implemented in an easy, cost effective and sustainable manner through optimal use of space, ease of installation and reconfiguration.

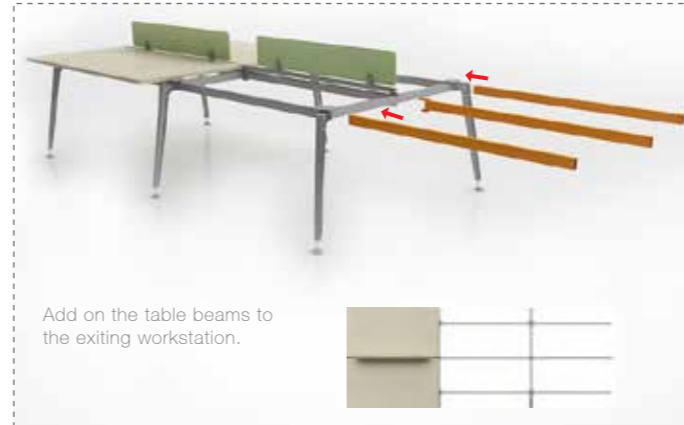

Add on the table beams to the exiting workstation.



Connect with table legs to set up the structure.

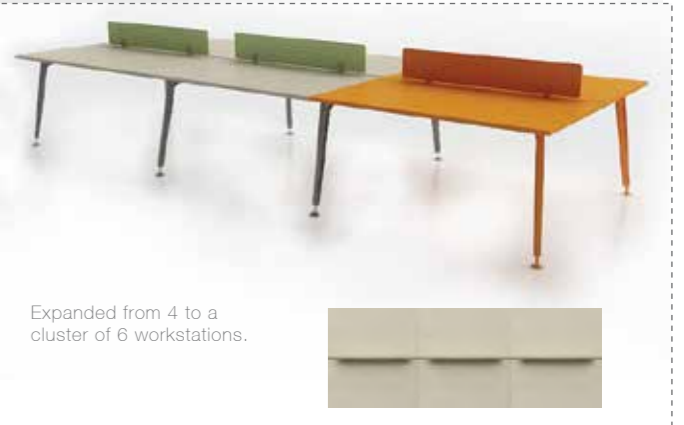

Expanded from 4 to a cluster of 6 workstations.

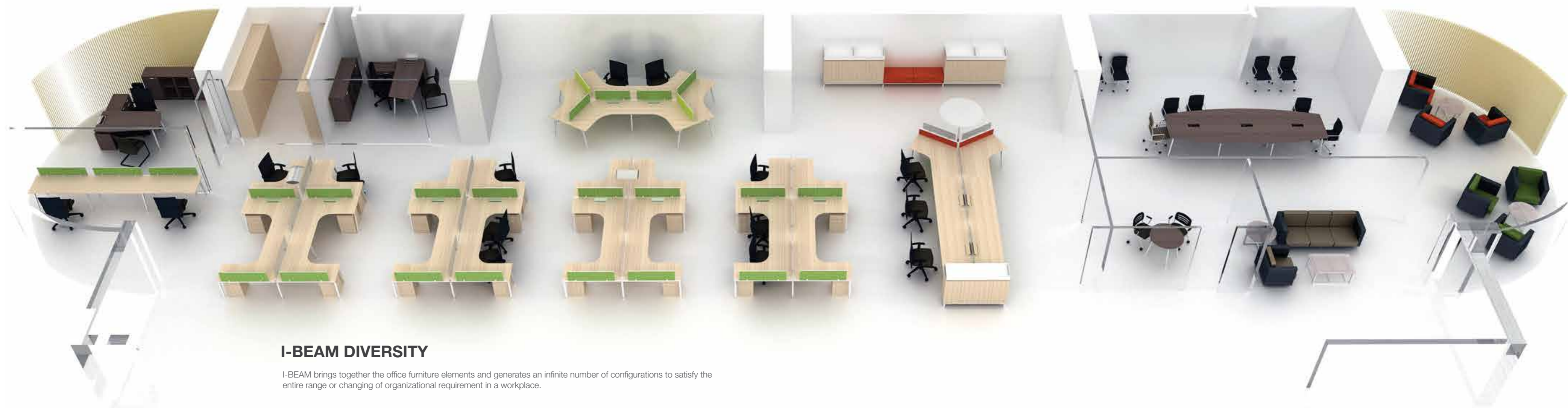

I-BEAM DIVERSITY

I-BEAM brings together the office furniture elements and generates an infinite number of configurations to satisfy the entire range or changing of organizational requirement in a workplace.



COMPACT STORAGE FOR ALL

People need quick and easy access to storage that helps them to manage their work and archive information. I-BEAM designed with integrated storages, allows people to use it for personal or shared basis.

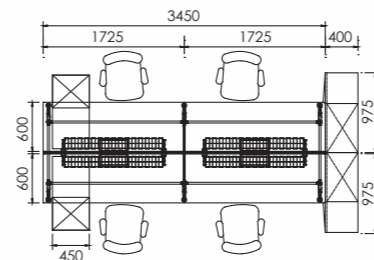



COLLABORATIVE WORKSTATION

I-BEAM facilitates collaborative working whilst also enables people to stay focused on the work. Implementation of privacy screen provides serenity to people to concentrate while working with associates.

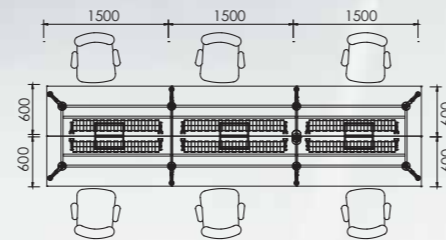

BENCH DESK DESIGN

I-BEAM benching solution offers an excellent choice for companies always looking for optimum team space. At the same time, it also provides individual storage and stationary accessories as integral element for people. Power and data is easily accessible on the desk for people.

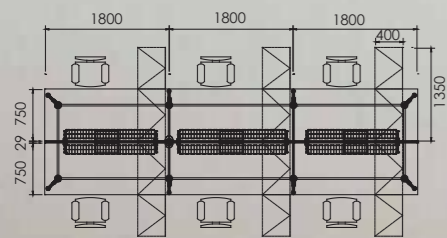

I-BEAM SYSTEM



LINEAR WORKSTATION



IDEAL FOR CONTEMPORARY SPACE

I-BEAM comes in cluster design with L-shaped worksurfaces which provides larger individual working surface, is ideal for project teams and work functions that requires larger work spaces.

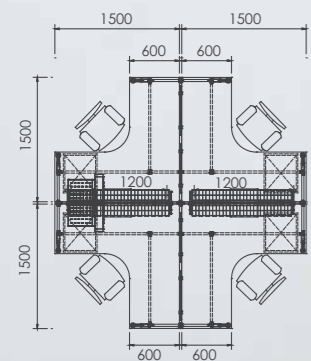



SMART SOLUTIONS FOR INDIVIDUAL AND TEAM WORK

I-BEAM enables shaping of dedicated workplace for privacy of individual task work and availability for collaborative teamwork. Panel set-up on the desk creates privacy space for confidential workspace. Integrated cable management is fully concealed inside wire riser and routed to worksurface for people to access it easily.

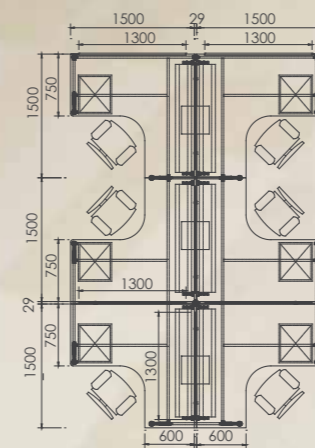

TEAMWORK IN THE WORKPLACE

People often require varying degree of interaction and collaboration throughout the day in a team. Implementation of I-BEAM from its simple and structural features in 120 degree workstation provides them a right condition. It supports varied work styles, job function and also encourages discussion between each other.

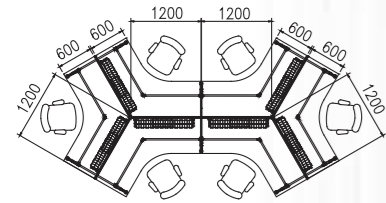



AMBIANCE OF FUNCTIONALITY & STYLE

An I-BEAM executive system combines a generous workspace with angled chamfered groove leg to float elegantly.

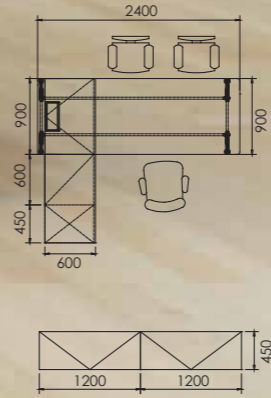

ADEQUATE PRIVACY

I-BEAM offers an intelligent idea for team managers who work alongside associates. I-BEAM executive system hybrid with Tri-X Plus panel is ideal for people who seek concentration.

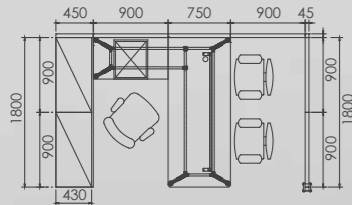



IDEAS FLOW WITH A CREATIVE FREEDOM

I-BEAM with its connector features allows it extend its size from a workstation to a large conference table easily. It offers a simple solution in meeting space for stimulating ideas, collaborations and discussions.

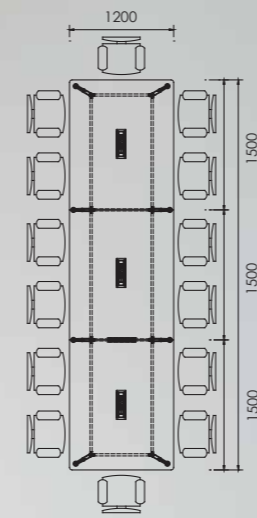



ELEGANT & FORMAL CONFERENCE SPACE

I-BEAM meeting table that comes in round shape with hollow space in the center part presents elegant and space solution for meeting or conference rooms. Power and data ports integrate on the worksurface provides the uses of laptops and conference call facilities during meetings straightforward. Netting modesty panels are optional choice.

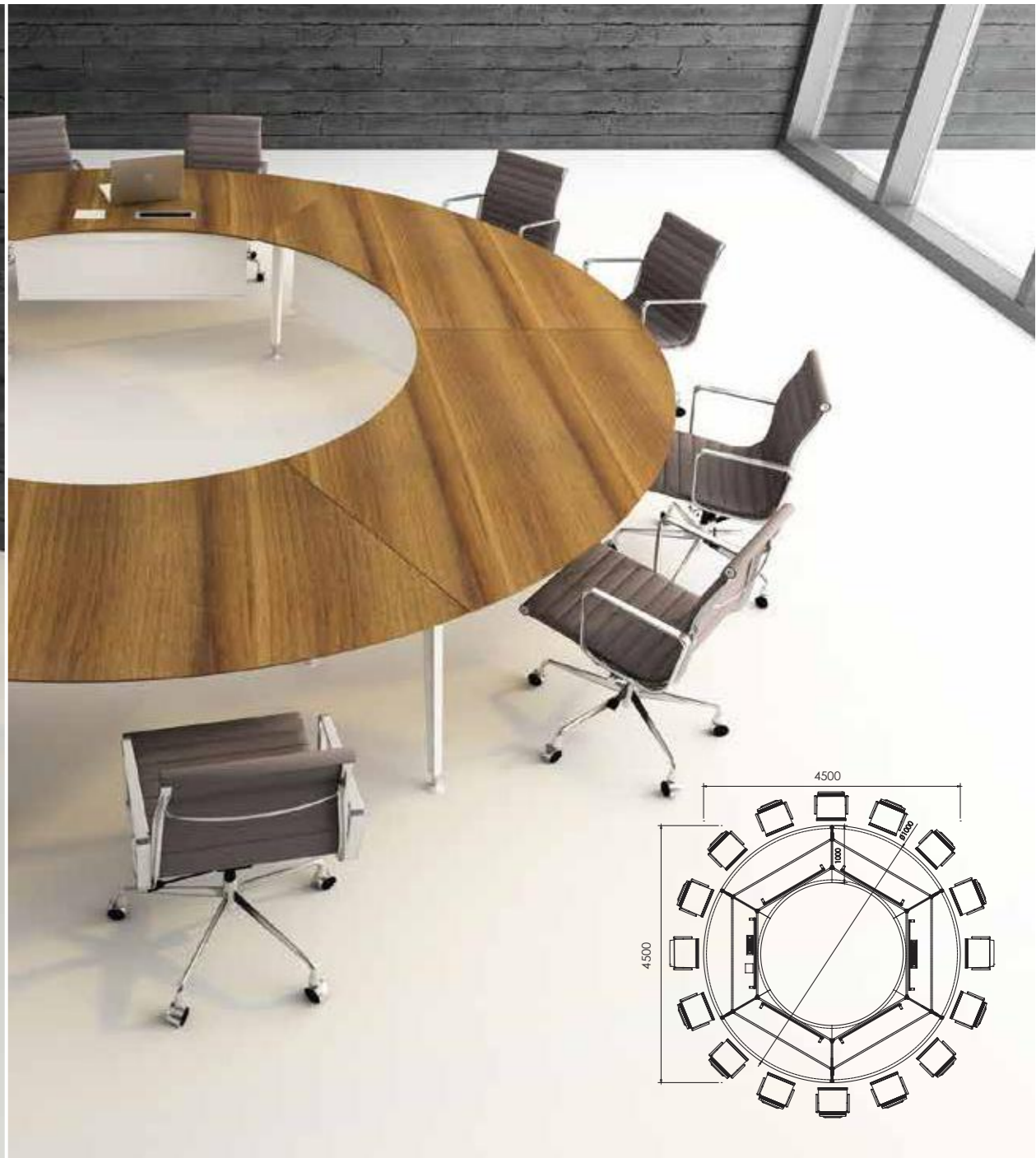

AN OPTIONAL SPACE FOR WAITING

I-BEAM bench designed as a waiting area in open space, lounge area or libraries. It combines integrated storage and bench together for a comprehensive solution in waiting area. The base in I-BEAM straight leg design, complement the I-BEAM bench.

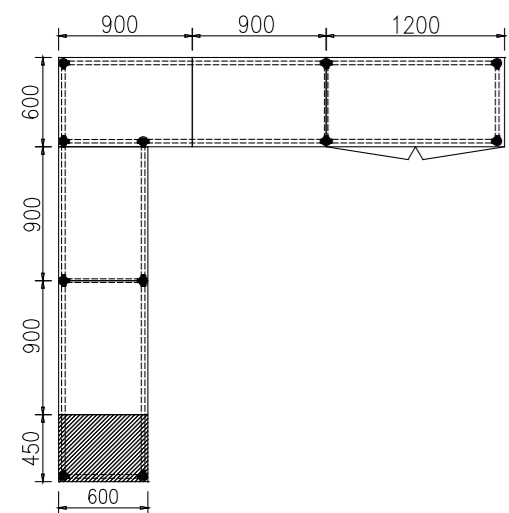

OPTIONAL:

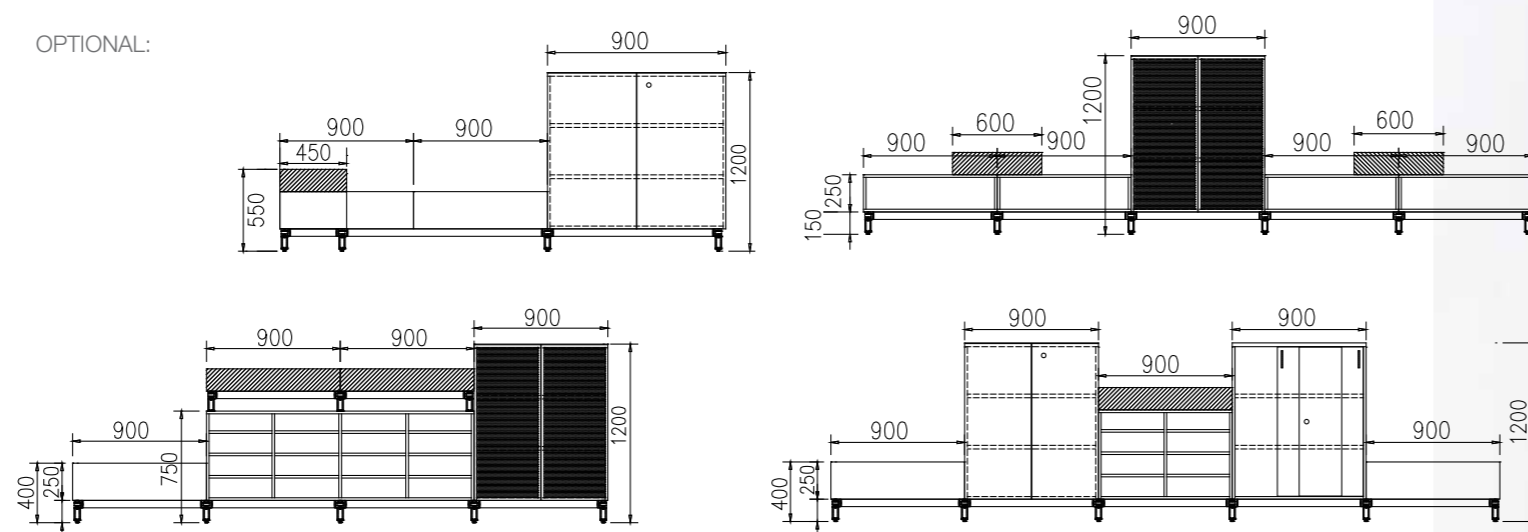

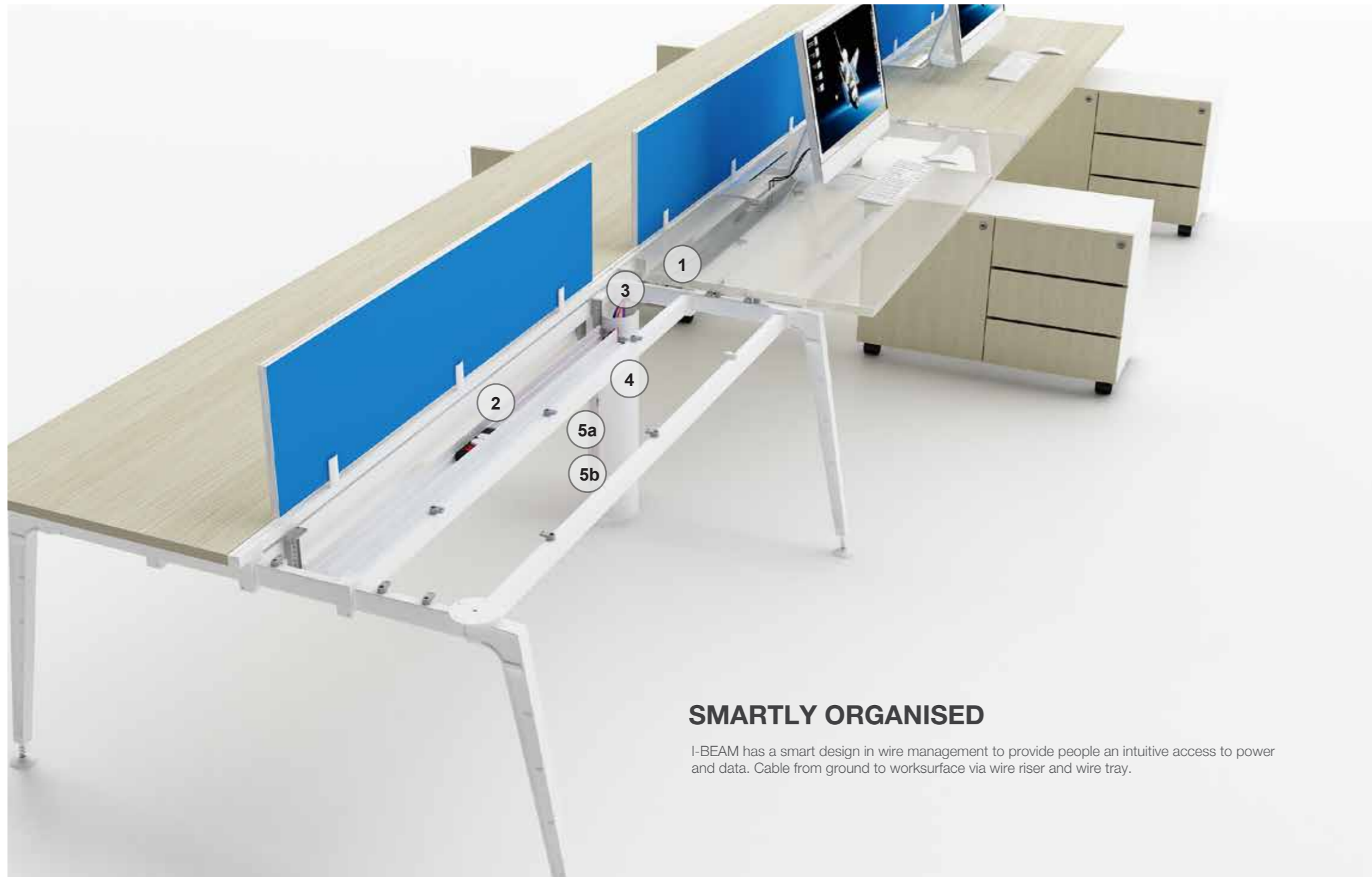

SMARTLY ORGANISED

I-BEAM has a smart design in wire management to provide people an intuitive access to power and data. Cable from ground to worksurface via wire riser and wire tray.



Aluminium wire tray comes with a PVC divider helps to keep the power and data cables discreet and in order.



Flip-up door on the worksurface allows people easy access to power and data within hand reach without cluttering the worksurface.

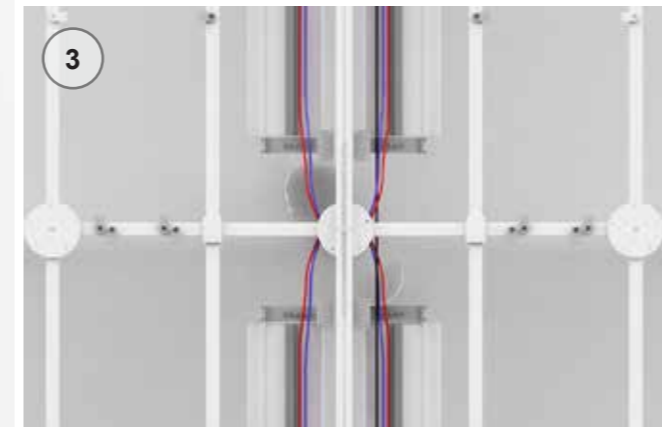

The wire riser routes the cables from ground and separates them tidily to those corresponding wire trays.

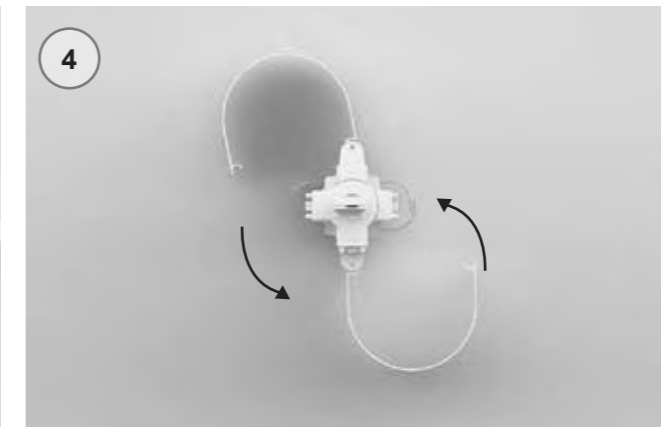

I-BEAM wire riser designed in pole shape for routing the cables from ground to wire tray. The special design of wire riser cover is opened by turning it in 90-degree to left and right side respectively.

OPTIONAL:



Massive High capacity cables route through the wire riser to the end of wire tray.



Adequate cables route through I-BEAM straight leg that equipped with nylon wire holder clips as an optional choices of wire management.

FEATURES



TABLE BUSH

Table bush is being applied on the table beam to act as a connector for the table top and creating a floating effect.



CABLE MANAGEMENT

That is a discreet cable distribution in I-Beam. The cables are well managed underneath the worktop by using the wire tray with nylon wire holder or wire riser. Cables are routed under the table top using wire tray that hooked to the metal beam with plastic wire tray holder. The wire tray can be adjusted easily from the holder.



TABLE SCREEN HOLDER

In I-BEAM system, table screen is mounting on the railway with aluminium die-cast U-bracket.



BEAM TO BEAM CONNECTOR

The metal connector clamps one beam to another beam in 90 degree to extend the workstation configuration.

THE ANGLES OF THE LEG

The leg can be configured in a variety of angles, from 60 degree to 300 degree to provide the flexibility for user to define how the workplace looks.

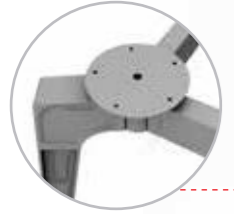

STRAIGHT LEG

I-Beam straight leg is equipped with the nylon wire holder clips for vertical wire management.

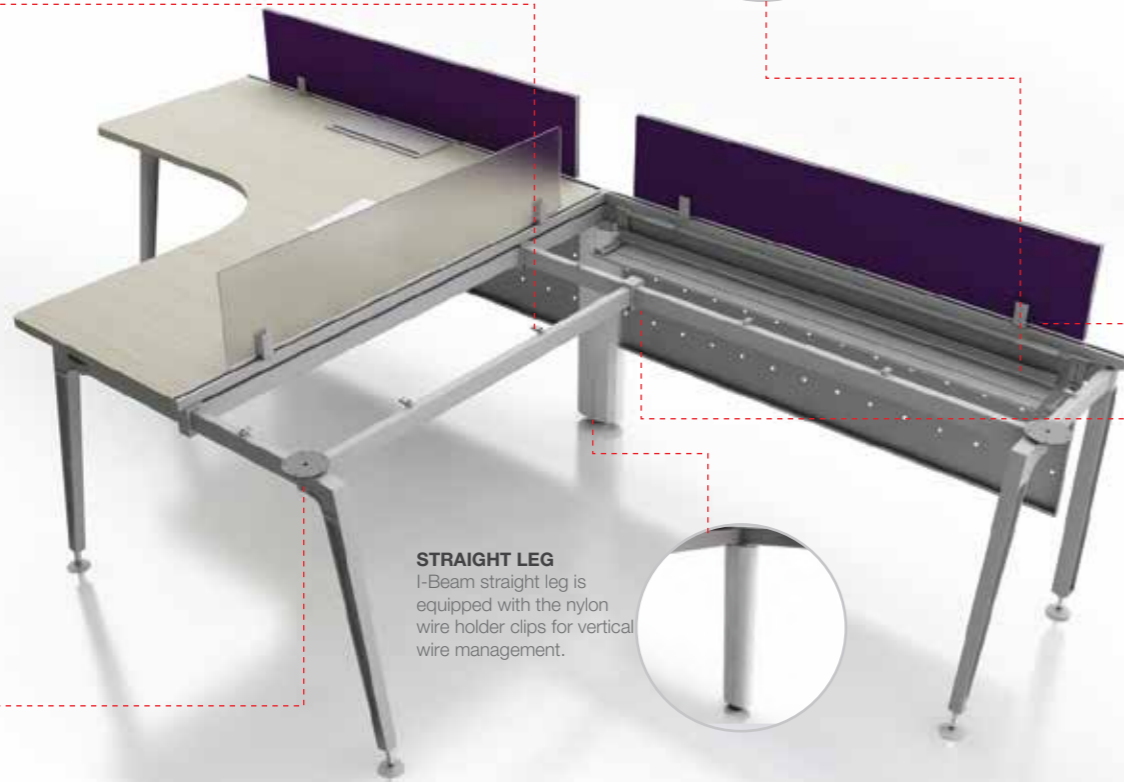

CHOICES

WIRE TRAY

I-BEAM wire tray comes with two choices, which are aluminium wire tray and basket wire tray. Aluminium wire tray build in with an optional PVC divider which act as an barrier to separate the power, voice and data cables in the same tray.



Single Basket Wire Tray



Double Basket Wire Tray



Single Aluminium Wire Tray



Double Aluminium Wire Tray

MODESTY PANEL

I-BEAM modesty panel is available in mesh netting and metal perforated design.



Mesh Netting



Metal Perforated

TABLE LEG FINISHES

I-BEAM legs are available in polish, chrome, and epoxy finishes apart from the straight leg which is only available in epoxy finishes. Epoxy finishes options: black, graphite, champagne, silver matt, silver metallic and tex white.



Tex White



Silver Metallic



Champagne



Black

TABLE SCREEN

I-BEAM privacy screen is available in I-Beam screen and IF panel. IF panel is a slim 18 mm panel with frameless design. While I-Beam screen is a groove edge designed 18 mm screen. Privacy screen finishes options: fabric, pinnable fabric, glass, whiteboard, polycarbonate.



IF Panel



I-Beam Screen

CLIENT LIST

MALAYSIA
 ABB Malaysia Sdn Bhd
 Affin Bank Berhad
 Agro Bank Berhad
 AIA Shared Services Sdn Bhd
 Aker Engineering Malaysia Sdn Bhd
 Al-Madinah International University
 Alliance Bank Malaysia Berhad
 Arup Jururunding Sdn Bhd
 Australian High Commission
 Axon Solutions Sdn Bhd
 Bank Islam Malaysia Berhad
 Bank Pembangunan Malaysia Berhad
 SME Bank
 Bank Muamalat Malaysia Berhad
 Bank Kerjasama Rakyat Malaysia Berhad
 BMW Malaysia Sdn Bhd
 Bursa Malaysia Berhad
 Carigali Hess Operating Company Sdn Bhd
 Carlsberg Brewery Malaysia Berhad (Carlsberg Malaysia)
 CCM Chemicals Sdn Bhd
 CIMB Bank Berhad
 Danajamin Nasional Berhad
 Deleum Berhad
 Dewan Bandaraya Kuala Lumpur (DBKL)
 Dutch Lady Milk Industries Berhad
 DVM Innovate Sdn Bhd
 Export-Import Bank of Malaysia Berhad (EXIM Bank)
 Fonterra Brands (M) Sdn Bhd
 Fresenius Medical Care (M) Sdn Bhd
 F & N Dairies (M) Sdn Bhd
 Great Eastern Life Assurance (Malaysia) Berhad
 Hitachi Data Systems Sdn Bhd
 Hong Leong Bank Berhad
 Honda Malaysia Sdn Bhd
 HSBC Global Resourcing (UK) Limited
 Huawei Technologies (M) Sdn Bhd
 Islamic Development Bank
 Istana Negara – Guest House
 Jabatan Kebudayaan dan Kesenian Negara
 Jabatan Kerja Raya Sarawak – Kuching
 Johnson & Johnson Medical Manufacturing Sdn Bhd
 Kenanga Investment Bank Berhad
 Komatsu Asia & Pacific Pte Ltd
 Kompleks Kementerian Dalam Negeri, WPKL
 Malaysia LNG Sdn Bhd – Bintulu
 Malaysian Agrifood Corporation Berhad (MAFC)
 Malaysian Communications & Multimedia Commission
 Malaysian Technology Development Corporation (MTDC)
 Mayban Fortis Holdings Berhad
 Malakoff Corporation Berhad
 MMC-Gamuda Joint Venture Sdn Bhd
 MNRB Holdings Berhad
 Naza Motor Trading Sdn Bhd

NUMed Malaysia
 Nomad Space Sdn Bhd
 Padiberas Nasional Berhad (BERNAS)
 Perbadanan Harta Intelek Malaysia (MYIPO)
 Seabadanan Usahawan Nasional Berhad (PUNB)
 Perwaja Steel Sdn Bhd
 Petrofac Malaysia – KLCC
 Petronas Carigali Sdn Bhd – KLCC
 Petronas Gas Berhad – Kertih
 Petronas Methanol (Labuan) Sdn Bhd
 Petronas Penapisan (Melaka) Sdn Bhd
 Petra Energy Berhad
 Pharmaniaga Lifescience Sdn Bhd
 Port Klang Free Zone Sdn Bhd
 POS Malaysia Berhad
 PPB Oil Palms Berhad
 Progressive Insurance Berhad
 Private Pension Administrator Malaysia
 Puncak Niaga Holdings Berhad
 Putrajaya 5G2
 -Ministry of Higher Education Malaysia
 -Ministry of Tourism Malaysia
 Putrajaya 4G8
 – Ministry of Rural & Regional Development
 Putrajaya 4G9
 – Ministry of Information, Communication & Culture
 Putrajaya 4G10
 – Ministry of Housing & Local Government
 Royal Embassy of Saudi Arabia
 Sarawak General Hospital
 Securities Commission Malaysia
 Singapore Airlines Ltd
 SIRIM Berhad
 SME Corporation Malaysia
 Sony (M) Sdn Bhd
 Sunway Group
 Sutherland Global Services
 Syarikat Bekalan Air Selangor Sdn Bhd (SYABAS)
 Talent2 Malaysia Sdn Bhd
 Talent Corporation Malaysia
 Tesco Stores (M) Sdn Bhd
 TNT Express Worldwide (M) Sdn Bhd
 Touch 'n Go Sdn Bhd
 Tradewinds (M) Bhd
 Universiti Teknologi MARA (UiTM), Sabah
 Universiti Teknologi Malaysia-Skudai
 UMW Corporation Sdn Bhd
 UM Land Builders Sdn Bhd
 UniKI MITEC
 Universiti Teknologi Malaysia (UTM)
 UOB Kay Hian Securities (M) Sdn Bhd
 Valuecap Sdn Bhd
 Volkswagen Group Malaysia Sdn Bhd
 Walton International Property Group (M) Sdn Bhd

Zuellig Pharma Sdn Bhd

INDIA
 3i Infotech Ltd
 Aker Powergas Pvt Ltd
 Alstom India Ltd
 Black & Veatch Consulting Pvt Ltd
 CBRE, Pune
 Citrix R & D India Pvt Ltd
 Cognizant Technology Solutions (CTS)
 Deloitte Communication Gym, Hyderabad
 Deloitte Consulting India Pvt Ltd
 DHL Express (India) Pvt Ltd, Mumbai
 DTDC, India
 Elkem India Pvt Ltd
 Emerson
 Enpro
 Esskay MEP Consultants (India)
 Financial Technologies (India) Ltd
 Fullerton Credit Company Ltd
 GE, Windson BKC
 Genesys Worldeye Ltd, Mumbai
 Glaze Granite Ltd
 Global eProcure
 Goldstar
 Hexaware Campus, Chennai
 HITOS
 HSBC
 iGate Clinical Research International Pvt Ltd
 ITB Software Service Ltd
 Ichibaan Honda Automobiles Pvt Ltd
 ICICI Bank
 Incubation Centre, Pune
 SME India Software Technologies Pvt Ltd, Bangalore
 JP Morgan & Co. Inc
 Jyothy Structures Ltd, Andheri West
 KOL
 Larsen and Toubro Ltd
 L'oreal India Pvt Ltd
 Marathon Maxima
 Mashreq Bank
 Mastek Ltd
 Max 90A Gurgaon
 Max Life Insurance Co. Ltd
 McKinsey Knowledge Centre India Pvt Ltd
 Melau Bank
 Mirae Asset global Investments Pvt Ltd, Chennai
 Morgan Stanley Capital International (MSCI) Barra
 N.Y.K. Logistics India Ltd, Andheri
 NCR Teradata, Pune
 ONGC Mangalore Petrochemicals Ltd (OMPL)
 Paternoster India Pvt Ltd
 Patni Computer Systems Ltd
 Praxis i-Technologies Pvt Ltd

Prime Technology Group, Hyderabad
 Regus India
 Reliance – New Delhi
 Saraswat Co-operative Bank Ltd, Mumbai
 Seairland Management Services (India) Pvt Ltd
 Sify Technologies Ltd, Chennai
 Sundaram BNP Paribas Fund Services Ltd
 Syntel India Ltd
 Tata Consultancy Services Ltd
 Tata Motors Ltd
 Tata Motors Finance Ltd
 Tata Capital Limited (TCL), Mumbai
 Thermax Ltd, Pune
 TNS India Private Ltd
 Transocean House
 Uhde India Ltd
 Unisource India
 Vodafone India Services Pvt Ltd
 WNS Global Services Pvt Ltd

PAKISTAN
 Lakson Tobacco Company Ltd
 Saima Packaging Pvt Ltd

MAURITIUS
 Arup Sigma Ltd
 CMA – CGM
 Euro CRM Mauritius Ltd
 Maurice Publicité
 POS
 SAB Miller
 Holiday Inn Airport Hotel

QATAR
 ICICI Bank, Doha

INDONESIA
 Bank Saudara
 Barclays Bank
 CIMB Bank
 Panin Bank

UAE
 AV Concepts LLC
 Alternative Capital Invest (ACI)
 Al Faris (Dubai and AbuDubai)
 Alstom
 Al Tayer Group
 Big Yellow Storage
 Carrefour, Dubai
 DP World Ltd
 Division Nine Interior Design (LLC)
 Dubai Islamic Bank

Dubai Municipality (Government of Dubai)
 Ducab
 Emaar
 Empire Aviation Group
 Goldline Group
 Hamptons
 JID Management Consultancy FZ LLC
 Kottoor International LLC
 Manchester Business School, Middle East Int. Centre
 Matrix Interiors Design LLC
 Modelcraft Pty Ltd
 Nakheel
 PCFC
 Premier Real Estate Bureau LLC
 Qanat Al Qasba Business Center
 Right Angle Media, FZ LLC
 S.S. Lootah Group
 Sify International
 Sika International Ltd
 The Independent Tobacco FZCO
 Thermax Ltd
 Zabeel Contracting Co. LLC

TANZANIA
 Skylink Travel & Tours Ltd
 The Living Room Ltd

UKRAINE
 CIB Engineering

UGANDA
 Bidco Uganda Ltd

BRUNEI
 Brunei Petroleum
 Malar Setia Sdn Bhd
 Ministry of Foreign Affairs and Trade
 Ministry of Education
 Ministry of Defence
 Ministry of Culture, Youth & Sports

CANADA
 Distrimar Inc

AUSTRALIA
 Commonwealth Bank of Australia
 Regus, Adelaide
 Stevens Commercial Furniture

CAMBODIA
 Ramatex Holdings Bhd, Phnom Phen

THAILAND
 Bangkok Business Media Co., Ltd.

B.B. Battery (Asia) Co., Ltd.
 Code Master Co.,Ltd.
 Dekor studio Co., Ltd.
 Engineering Evolution Co., Ltd.
 First Chapter Co.,Ltd.
 Green Asset Management Co., Ltd.
 JP Architects & Associate Co.,Ltd.
 Sappakit Administration Co.,Ltd.
 Sigma Agrochemical Co., Ltd.
 STRABAG Industries (Thailand) Co.,Ltd.
 Taweekun Instructional Media Co.,Ltd.
 Thai Advance Electric Sales & Service Co.,Ltd.
 Thai Vista Enterprise Co., Ltd.
 Thailine Resources Co.,Ltd.
 The Government Savings Bank (Tiwanon Branch)
 The Nomad Offices, Bangkok
 Total Access Communication Public Company Limited
 Tree Square Studio Co., Ltd.
 Use Electronics (Thailand) Co.,Ltd.
 V-Intelligence Co.,Ltd.
 Yong Thai Seng Co., Ltd.

SINGAPORE
 Ang Mo Kio Police Station
 Baker & McKenzie.Wong & Leow
 BNP Paribas Private Bank
 Credit Agricole Corporate & Investment Bank
 Crimson Logic Pte Ltd
 Cummins Corporate Office
 Cummins Diesel Sales Corporation
 Cummins Engine (S) Pte Ltd
 Cummins Power Generation (S) Pte Ltd
 Dou Yee Enterprises (S) Pte Ltd
 Goodrich Aerostructures Service Center Asia Pte Ltd
 Great Eastern Life Assurance Co. Ltd
 Holiday Inn Park View Hotel Singapore
 John Willies & Sons
 Kalla Group
 Knight Frank Pte Ltd
 Luxasia Pte Ltd
 National Cancer Centre Singapore
 National Computer Systems Pte Ltd
 National Library
 Savi Technology Asia Pte Ltd

Schaefer Systems International Pte Ltd
 Schroder Investment Management (S) Ltd
 Sembawang Corporation
 Sembawang Engineers & Constructors Pte Ltd
 Singapore Economic Development Board
 Singapore Press Holdings Ltd
 Straco Corporation Ltd
 Sumifru Singapore Pte Ltd
 The National Library Board, Library Supply Centre
 Toshiba
 Universal Terminal (S) Pte Ltd
 UOB Life Assurance Ltd

MYANMAR
 Mingalar Zay Office
 Shwe Taung Cement Co. Ltd

BAHRAIN
 Collage Consultants WLL

I-BEAM TEST CERTIFICATE



BIFMA CERTIFICATES



Artmatrix is qualified as an International Member of BIFMA (Business & Institutional Furniture Manufacturers Association).



ARTMATRIX TECHNOLOGY SDN BHD (694144-X)
ARTMATRIX MANUFACTURING SDN BHD (693659-U)
ARTMATRIX OFFICE SYSTEM SDN BHD (837645-K)
 Lot 32789, Jalan 5/1A, Taman Perindustrian Selesa Jaya,
 43300 Balakong, Selangor Darul Ehsan, Malaysia.
 ☎ +603 8962 2286 📠 +603 8961 8862
 ✉ sales@artmatrix.com.my 🌐 www.artmatrix.com.my



KK SHOWROOM
 B-07-3, 3rd Floor, Lot 7, Block B, Kota Kinabalu Times Square,
 Off Coastal Highway, 88100 Kota Kinabalu, Sabah, Malaysia.
 ☎ +6088 44 8355 / 44 8655 📠 +6088 44 8455



ARTMATRIX UAE (LLC)
 PO Box 111497, AL Quoz, Dubai, UAE.
 ☎ +9714 3419156 📠 +9714 3419157 🌐 www.artmatrix.ae



Licence No : ART7 / International / 2011
 Standard : GE5/19/2011-Interior fittings



ART-2011
 GECA 28-2006 v. 1.10-
 Furniture and Fittings



Top 10 Outstanding
 SMEs - Ranked 3rd



Export Excellence
 Award



Product Excellence
 Award



The Brand Laureate -
 SMEs Chapter Awards 2009



The Brand Laureate -
 SMEs Chapter Awards 2010



Enterprise 50
 Award 2009



HONESTY INTERNATIONAL
 HONESTY ENTERPRISE
 AWARDS 2009

