



**E-STILTS**  
simple and ingenious



## E-STILTS concept

Inspired by stilts house – a pile dwelling that come with raised structure, and normally built over sand or above water, "E-Stilts" is created as our new leg. As found in Wikipedia, "Stilts" are pillars or posts to allow a structure to stand at a height above the ground, "E-Stilts" has come up to act as a desking system. Stilts house which is easy to construct and protect against nature elements of flood and earthquake applies to E-Stilts understructure. It act as a pile driver of strength on its foundation.

E-Stilts act as a simple, ingenious, and adaptive bench, for entire range of application in open workplace. It is a re-configurable bench and suitable for any demands of office environment. On this basis, E-Stilts is offering a great flexibility to works across a wide range of configuration demands, from staff workstation to manager workstation and to conference table.









## LINEAR

Teams need places that allow them to see their teammates comfortably, hear each other clearly and share information easily in order to build social capital and the "shared mind" that is necessary to bring innovation to successful conclusion. E-Stilts design offers a comfortable place to work, focused and maximise interaction between each other.

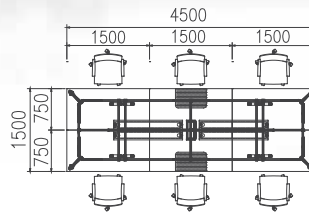

OTHER CONFIGURATIONS :

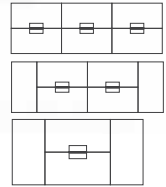

## L-SHAPED

Versatile working scenarios with add-on table for additional surface space and storage unit as storage space for documents with modern style and simple modularity that delivers on form and functions.

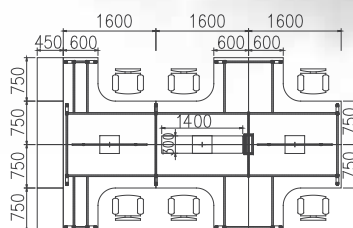

OTHER CONFIGURATIONS :

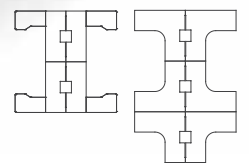



## 120 DEGREE

A 120 degree planning design system can create higher workstation densities to optimise the office layout, that help employees engage and amplify the performance of people, teams and organizations.

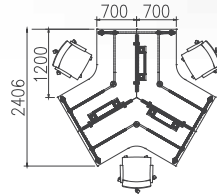

OTHER CONFIGURATIONS :

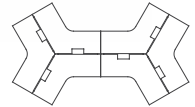

## EXECUTIVE

E-Stilts creates ecosystem with palette of posture-spaces that encourage people to sit, discuss, stand and move through their day, while supporting the different kinds of work they do and the multiple technologies they use.

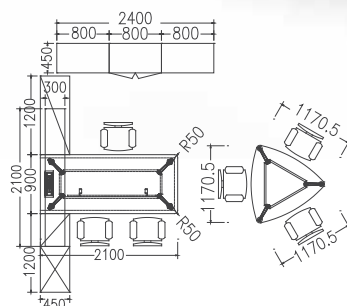

OTHER CONFIGURATIONS :

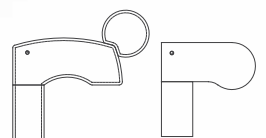



## CONFERENCE TABLE

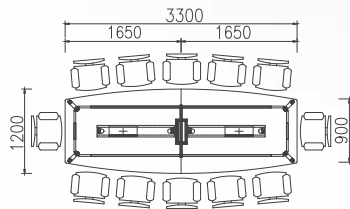

OTHER CONFIGURATIONS :

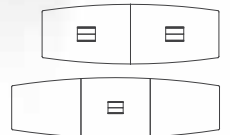

## BENCH

E-Stilts bench was created to solve the challenges of today's waiting places. A modular system that can be reconfigured in many ways for many applications.

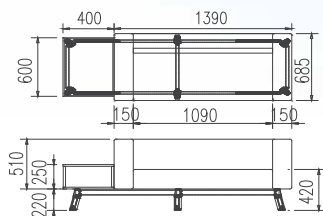

OTHER CONFIGURATIONS :

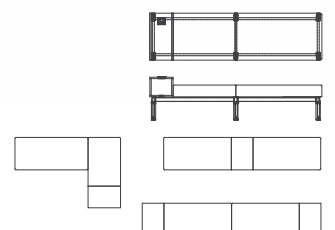

## E-STILTS UNDERSTRUCTURES

E-Stilts understructure is available in 4 type designs , according to user requirements and office layout arrangement.



Understructure 1



Understructure 2

Understructure 3

Understructure 4

### E-STILTS Adjustable Leg

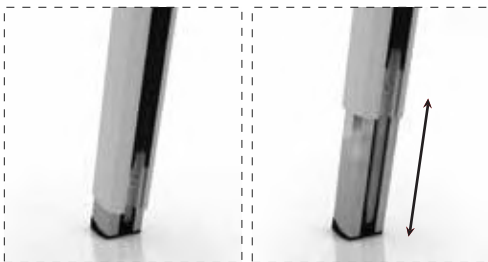

E-stilts system also act as height adjustable table to allow people to adjust the height of table from H675 to H825.

### E-STILTS Table Arm

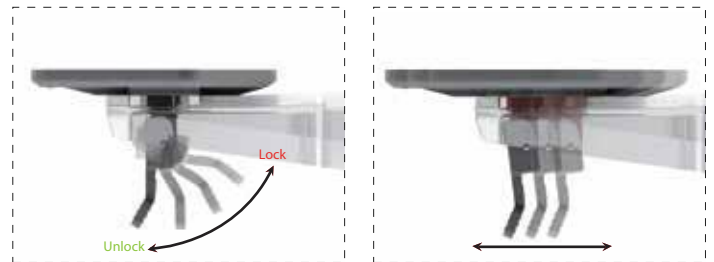

E-Stilts table arm come with locking mechanism, to attach to table top without bolts and nuts with approximately 10 mm of free movement. This table arm also can be applied in Trendx Pro System.

# FLEXIBLE & EFFICIENCY RECONFIGURATION

## ONE SIZE DOESN'T FIT ALL

In table top extension, E-Stilts can be extended in length of L150 and L300. This table top extension function normally is applicable for conference table.





## PRACTICE SOLUTION TO CATER MANY DIFFERENT NEEDS AND BEHAVIORS

Add-on table without removing the existing table top. This table extension function normally is applicable for staff workstation in linear and L-shaped.



Cluster of 4 Understructure



### Add on

Remove the end cap on existing table leg and add on the table beams on it.



Cluster of 6 understructure



## WIRE MANAGEMENT

Intelligent designed wire management solution makes E-Stilts neat and easy to route power and data up to worksurface.



**STAFF WORKSTATION**

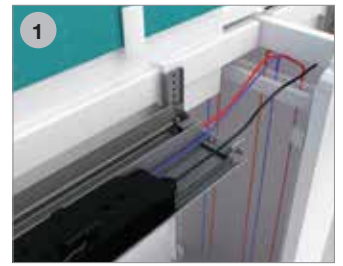

Aluminium wire tray drives wires underneath the desk and uses metal wire riser box for storing massive wires, creates effective wire management solutions in workplace.



There is an optional way to route wires to table top, via E-Stilts table leg. This is ideal for executive workstation whose wire is small in capacity.



**EXECUTIVE WORKSTATION**



Aluminium flip up door's smart design allows user to open with the simple push of a button.

### E-STILTS Leveler



Manual regulation leg that can be adjusted by just using a screwdriver.

# E-STILTS OVERVIEW

## A LEG PROFILE



Slant leg with table arm

### OPTION



Straight leg with table arm



Slant and straight leg with table arm



Slant leg



Straight leg

## B TABLE ARM



For MFC top

### OPTION



For glass top

## C PANEL



IF Panel

### OPTION

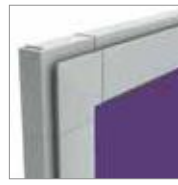

I-Beam Panel

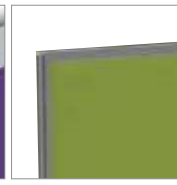

TrendX Pro Panel



Glass Panel

## E WIRE RISER



Wire Riser Box  
L220 x D160

### OPTION



Wire Riser Box  
L350 x D160



Wire Riser Box  
L500 x D160



i-Beam Wire Riser  
L110 x D160

## D WIRE TRAY

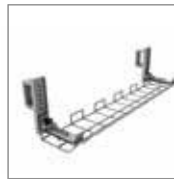

Basket Wire Tray

### OPTION



Aluminium Wire Tray

Disclaimer: All images are for illustration purposes only, subject to change without prior notice.

## FIRA Certificate



## GECA Certificate





**ARTMATRIX TECHNOLOGY SDN BHD** (694144-X)  
**ARTMATRIX MANUFACTURING SDN BHD** (693659-U)

Lot 32789, Jalan 5/1A, Taman Perindustrian Selesa Jaya,  
 43300 Balakong, Selangor, Malaysia.

☎ +603 8962 2286 📠 +603 8961 8862

✉ sales@artmatrix.com.my

🌐 www.artmatrix.com.my



ISO 9001 Certified



ISO 14001 Certified

**KK SHOWROOM**

B-07-3, 3rd Floor, Lot 7, Block B, Kota Kinabalu Times Square,  
 Off Coastal Highway, 88100 Kota Kinabalu, Sabah, Malaysia.

☎ +6088 448 355 / 448 655

☎ +6088 448 455

International member of



Furniture Industry Research Association



BUSINESS • INSTITUTIONAL FURNITURE MANUFACTURERS ASSOCIATION



Licence No: ARX International 2014  
 Standard : GES/ BF/ 2011-Interior fittings



ARKX-2014  
 GECA 20-2006+2  
 Furniture & Fittings



green building index



MALAYSIA Hijawal



Prime Minister's Hibiscus Award 2014/2015  
 Notable Achievement in Environmental Performance



SINGAPORE GREEN BUILDING COUNCIL MEMBER



Top 10 Outstanding SMEs - Ranked 3rd



Export Excellence Award



Product Excellence Award



The Brand Laureate - SMEs Chapter Awards 2010



Enterprise 50 Award 2009



INTERNATIONAL HONESTY ENTERPRISE AWARD 2008