



# XENIC

Gifted by nature





## Xenic True Spirit

Every great design begins with an even great story. Joe Leong, designer of Artmatrix reveals the beauty of nature. This timeless office chair was inspired by the dance of the multi-colour butterfly, and now its wings are fully supporting and caressing the lumbar for a comfortable sitting posture.

New developments in materials, usage concepts and social trends repeatedly transformed Xenic beyond its limit. Also, Xenic adds a vivid ambience in modern office environment and passes the significance of innovation for an office chair.

*Gifted by nature*



## Comfort, Classic and Elegance

People are spending most of the time at work sitting in an office chair. An ergonomic chair provides not only the proper function but ensures people to be able to sit and be productive for a longer duration.

Xenic chair comes in 2 options, basic range or advanced range with reliable support and unexpected comfort in a sophisticated design. Xenic basic range features breathable yet high performance suspension back, optional lumbar support is available in Xenic advanced range for added comfort at the lumbar areas.

Xenic equipped with single-axis adjustable lumbar support and seat depth adjustment that enable users to get into comfortable posture quickly and improve working experience. Variety colour selection for headrest and seat textiles, backrest, lumbar support and base finishes, Xenic can be customized to match any palette in any environment.





## XENIC - BASIC RANGE



CODE : **XTXN-MB-B-GY**

Fabric Colour	JAMAICA
---------------	---------



CODE : **XPXN-MB-B-GY**

Fabric Colour	SCUBA
---------------	-------



CODE : **XTXN-MB-B-BK**

Fabric Colour	CALYPSO
---------------	---------



CODE : **XYXN-MB-B-BK**

Fabric Colour	SLIP
---------------	------



CODE : **XPXN-HB-B-GY**

Fabric Colour	MARTIQUE
---------------	----------



CODE : **XTXN-HB-B-GY**

Fabric Colour	WINDJAMMER
---------------	------------



CODE : **XPWN-HB-B-BK**

Fabric Colour	BERMUDA
---------------	---------



CODE : **XYMN-HB-B-BK**

Fabric Colour	DEMERERA
---------------	----------

## XENIC - ADVANCED RANGE



CODE : **XPXS-MB-A-GY**

Butterfly Colour	
Fabric Colour	PASED



CODE : **XTXS-MB-A-GY**

Butterfly Colour	
Fabric Colour	CALYPSO



CODE : **XYXN-MB-A-BK**

Butterfly Colour	
Fabric Colour	WINDJAMMER



CODE : **XYWS-MB-A-BK**

Butterfly Colour	
Fabric Colour	PASED



CODE : **XPWS-HB-A-GY**

Butterfly Colour	
Fabric Colour	CAYMAN



CODE : **XTXS-HB-A-GY**

Butterfly Colour	
Fabric Colour	SLIP



CODE : **XPWS-HB-A-BK**

Butterfly Colour	
Fabric Colour	SCUBA



CODE : **XPMN-HB-A-BK**

Butterfly Colour	
Fabric Colour	HULA

# FEATURES

## Supportive Backrest

Mesh designed backrest is ergonomically curved to fit your body and its breathable mesh provides comfortable sensation even after long hours of sitting.

## Changeable Headrest Cover

The innovative changeable seat cover, allowing ease of replacing the headrest cover for cleanliness and colour matching.

## Armrest

Xenic polypropylene armrest is ergonomically designed with slight curve to allow your hands to rest comfortably. It is available in height adjustable or fixed armrest.

## Changeable Seat Cover

The innovative changeable seat cover comes with velcro feature, allowing ease of replacing the seat cover for cleanliness and colour matching.

## Adjustable Lumbar Support

Xenic lumbar support is made of High Density Polyethylene (HDPE), a lightweight and high tensile strength plastic that is recyclable yet environmentally friendly.

## Polypropylene seat shell

Polypropylene seat shell which made of recycled material is durable and eases of changing seat cover.

## Dualwheel Nylon Castor

Xenic sturdy 60 mm dualwheel nylon castor provides smooth gliding on floor and even carpet.



# FUNCTIONS



**Xenic Adjustable Armrest**  
The optional 2D adjustable armrest provides adjustment for height and sideways angle to support wrists and forearms comfortably.

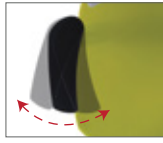

**Mars Adjustable Armrest**  
The optional height adjustable armrest with polyurethane armpad for comfortable support.



**Adjustable Lumbar Support**  
Xenic lumbar support comes together with spring load adjustment, which allows you to adjust it in various heights and keep your spine in the correct position.

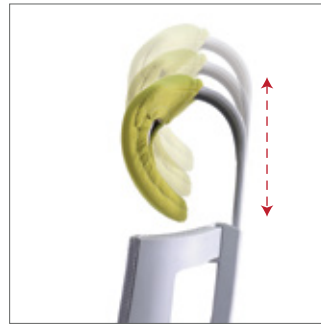

**Adjustable Headrest**  
The nylon headrest with height adjustment and intuitively bend function allows a greater flexibility to adjust your posture for utmost comfort along with colourful fabric cover.



**Synchronized Multi-locking Mechanism**  
Automatically coordinates your seat and back movement, and lock your ideal position in 3 lockings position to suit your posture.

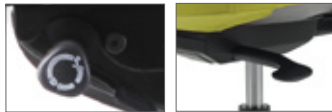

P Mechanism T Mechanism



**Synchronized Mono-locking Mechanism**  
Automatically coordinates your seat and back movement, and lock your position into one selected position.



Y Mechanism



**Tilt Tension Adjustment**  
Provide appropriate reclining control to find your ideal resistance according to your body weight.



P Mechanism Y Mechanism



**Seat Depth Adjustment**  
Xenic adjustable seat depth allows you to slide the seat pan to accommodate different leg length for greater comfort.



P Mechanism



**Seat Height Adjustment**  
Adjust the seat so that your feet are resting flat on the floor and there is minimal pressure on the back of your thighs.



P Mechanism T Mechanism



Y Mechanism

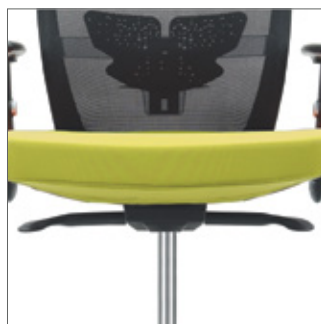

**Self-weight Adjustment**  
Self-adjust based on your weight to provide perfect recline with the correct tension.

## XENIC SEAT IN NATURAL LATEX



\* Natural latex seat is applied only in Xenic Chair

Xenic seat uses natural latex foam obtained from the sap of rubber tree. It provides natural spinal support and maximum comfort. The small pinhole design on the cushion offers excellent ventilation to promote air circulation on your seat.

In addition, Xenic cushion is resistance to compression and contoured to your body shape.

A Xenic chair seat in latex foam produces 75.56 kg CO2 eq carbon footprint compared to Xenic chair seat in PU foam that produces 81.2 kg CO2 eq. Hence by choosing latex foam, a Xenic chair will produce a lower life cycle carbon footprint.

With this seat cushion made of natural latex, the entire chair becomes a highly sustainable product and qualified as a "GREEN CHAIR".



### Carbon footprint of Xenic at different stages:

Stages	Kg CO2 eq	%
Production	68.07	90
Transportation	0.95	1
Disposal	6.54	9
Total	75.56	100

- This product has been independently verified for Environmental Product Declaration.
- The environmental impacts of this product are relatively low given the inert nature of the materials used.
- We have committed to reduce the carbon footprint of this product.

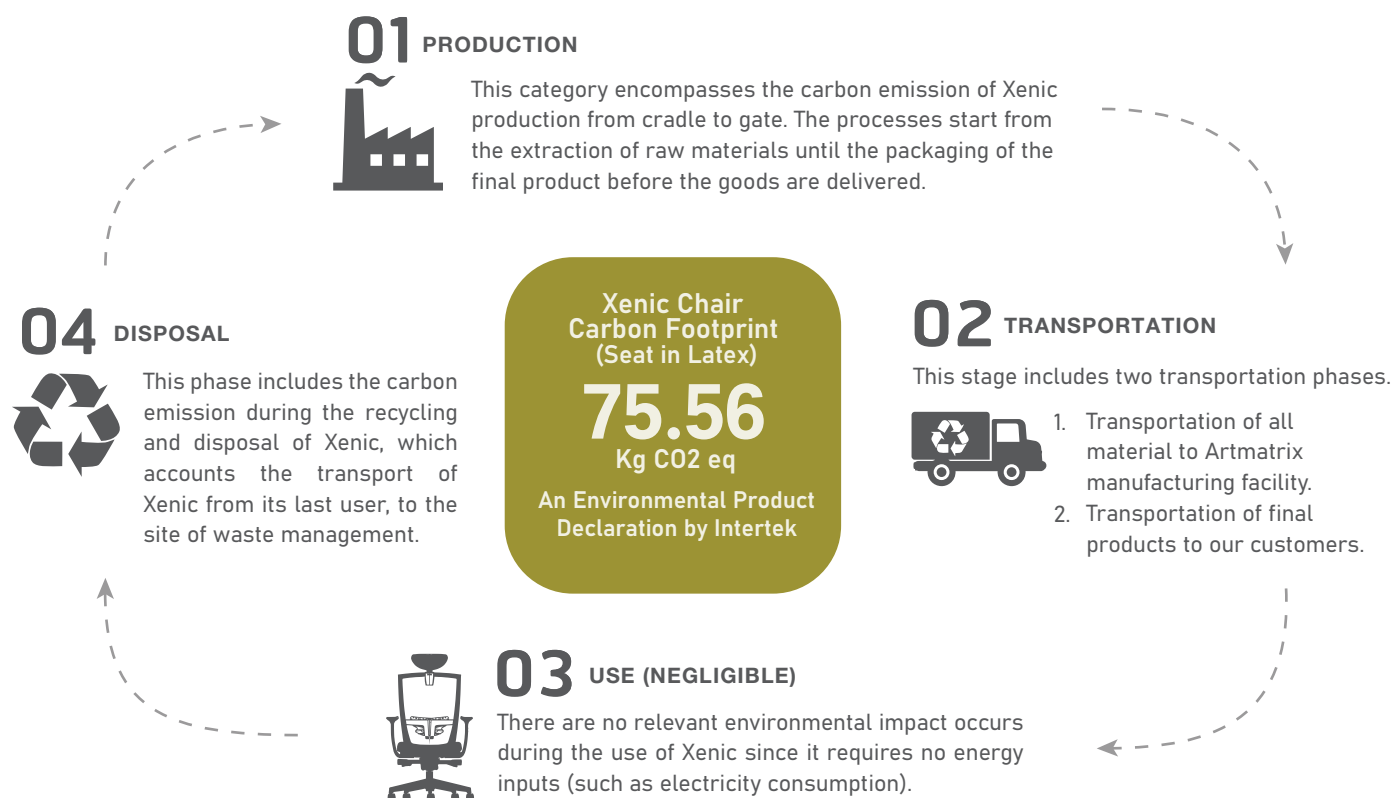



# CERTIFICATIONS

## GECA

Licence No : ART-2021



GECA (Good Environmental Choice Australia) manages a Type 1 Ecolabel program in accordance to ISO 14024 "Environmental Labels and Declarations" and is the owner of the Good Environmental Choice Australia Ecolabel.

The following products and/or services have been granted the use of the ecolabel and have been verified by an independent conformity assessment body that they meet the environmental, health and social/ethical criteria of the GECA standard.

**Licence number:** ART-2021  
**Issued to:** ARTMATRIX TECHNOLOGY SDN BHD  
**Issue date:** 27 January 2021  
**Licence since:** 04 March 2011

**Certified products:**

I-Made (ECO) Desking System	I-Beam (ECO) Desking System
Simplex (ECO) Monolith Panel System	8-Beam (ECO) Desking system
Ti-X Plus (ECO) Monolith Panel System	Xena Chair
Trendix Pro (ECO) Desking System	Xena Chair Range
IF (ECO) Intelligent Folding Table	

**GECA standard:** FFFMAS 1:2017 Furniture, Fittings, Foam and Mattresses  
**Address of head office:** Lot 32789, Jalan 5/1a, Taman Perindustrian Selesa Jaya, Balakong, Selangor 43300, Malaysia  
**Conformance assessment by:** Bureau Veritas  
**Licence expiry date:** 04 July 2023

*Michelle Thomas*  
**Michelle Thomas**  
 Acting Chief Executive Officer

Suite 302, Level 3, 77 Dunning Avenue  
 Rowang, NSW 2019  
 P: +612 9699 2850  
 ABN: 27 118 766 153



Our vision is for a sustainable future for people and planet

## ANSI/ BIFMA

Test Report : 120050050



### TEST CERTIFICATE

This Certificate is issued to  
**ARTMATRIX TECHNOLOGY SDN BHD**  
 LOT 32789, JALAN 5/1A,  
 TAMAN PERINDUSTRIAN SELESA JAYA,  
 43300 BALAKONG,  
 SELANGOR, MALAYSIA

**FOR**

Product : HIGH BACK SWIVEL CHAIR WITH FIXED ARMREST  
 Brand/ Model : XENIC  
 Detail :  
 Specification : ANSI/BIFMA X5.1-2017 – GENERAL-PURPOSED OFFICE CHAIRS - TESTS  
 Test Report No : 120050050  
 Date of Test Report Issued : JUNE 29, 2020

**SUMMARY:**  
 A sample of the product has been tested and is found to meet with the requirement of the above specification.



*Smapule*  
 Guardian Independent Certification Pte Ltd

Certificate No: 120050050      Date of Original Issue: JUNE 29, 2020      Date of Last Revision:      Date of Expiry: JUNE 28, 2022

This Certificate remains the property of Guardian Independent Certification Pte Ltd and shall be returned upon request. The use of the certificate is subject to the terms and conditions of the Test Certification Scheme.  
 Note: This certificate is issued pursuant to the terms set out overleaf.

## MyHIJAU Licence

Liting No : MyHP000080/15-B009

This is to certify that

**ARTMATRIX TECHNOLOGY SDN. BHD.** (18841483)  
 Lot 32789  
 Jalan 5/1a, Taman Perindustrian Selesa Jaya  
 43300 Balakong  
 Selangor

has the rights to use the MyHIJAU Mark on the following item:  
 (Refer to Schedule Page for more details)

**Compliance Category:**  
 Green Label Certification (ISO 14024 Type I ECO-Labels)

**Certification Scheme:**  
 Environmental Choice Australia Ecolabel

Certificate no.: MyHP000080/15  
 Issue Date: 24-03-2021  
 Expiry Date: 21-03-2024



Malaysian Green Technology And Climate Change Council  
 No 5, Jalan 8/25, Persiaran (Kuching) Selesa Jaya, 43200 Bandar Baru Bangi, Selangor Darul Ehsan, Malaysia  
 T: 03-8921 8888  
 F: 03-8921 8883  
 www.myhijau.org  
 www.greenchoice.com.my

This is a computer generated certificate hence no signature is required.

This certificate is granted subject to the Terms and Condition of usage of MyHIJAU Mark certificate and label.

Certificate No. : MyHP000080/15  
 Issue Date : 24-03-2021  
 Expiry Date : 21-03-2024

### SCHEDULE PAGE

Item #	Item Name	Brand	Model	Sector
MyHP000080/15-B003	SIMPLEX (ECO) Monolith Panel System	ARTMATRIX	ECO Series	Building
MyHP000080/15-B004	TRENDIX PRO (ECO) Desking System	ARTMATRIX	ECO Series	Building
MyHP000080/15-B005	I-MODE (ECO) Desking System	ARTMATRIX	ECO Series	Building
MyHP000080/15-B006	Ti-X PLUS (ECO) Monolith Panel	ARTMATRIX	ECO Series	Building
MyHP000080/15-B007	IF (ECO) Intelligent Folding Table	ARTMATRIX	ECO Series	Building
MyHP000080/15-B008	I-BEAM (ECO) Desking System	ARTMATRIX	ECO Series	Building
MyHP000080/15-B009	XENIC Chair	ARTMATRIX	ECO Series	Building
MyHP000080/15-B002	6-STYLTS (ECO) Desking System	ARTMATRIX	ECO SERIES	Building
MyHP000080/15-B001	Xena Chair Range (Chair, Meeting and Seating)	ARTMATRIX	XENA chair range (Chair, Meeting and Seating)	Building

**END PAGE**

## AVAILABLE OPTIONS

### Armrest Options:



X - Xenic fixed armrest



M - Mars adjustable armrest



W - Xenic adjustable armrest

### Base Options:



N - Nylon base



S - Aluminium polished base

### Mechanism Options:

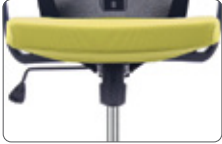

Y - Synchronized monolocking



T - Self-weight adjustment with synchronized multilocking



P - Seat depth adjustment with synchronized multilocking

### Seat Options:



Polyurethane foam



Latex foam

## COLOUR OPTIONAL

### Lumbar Support Colours:



Black



Grey



White



Blue

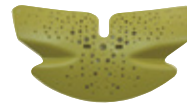

Green



Orange

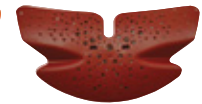

Red

### Frame Colours:



Grey



Black

### Backrest Super Net Mesh Colours:



Hot orange

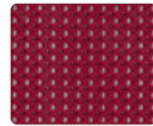

Chilli red

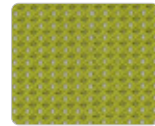

Apple green

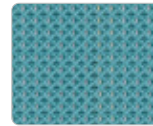

Turquoise



Steel grey



Black

### Seat Vertex Fabric Colours:



Arecibo



Cayman



Scuba



Martique



Demerera



Hula



Windjammer



Slip



Pased



Bermuda



Dessert



Calypso



Jamaica



Bahamas



Taboo



Black glory

Disclaimer: Colour shown may not be an accurate representation of the actual colour, please refer to actual colour samples for final confirmation.

# DIMENSIONS

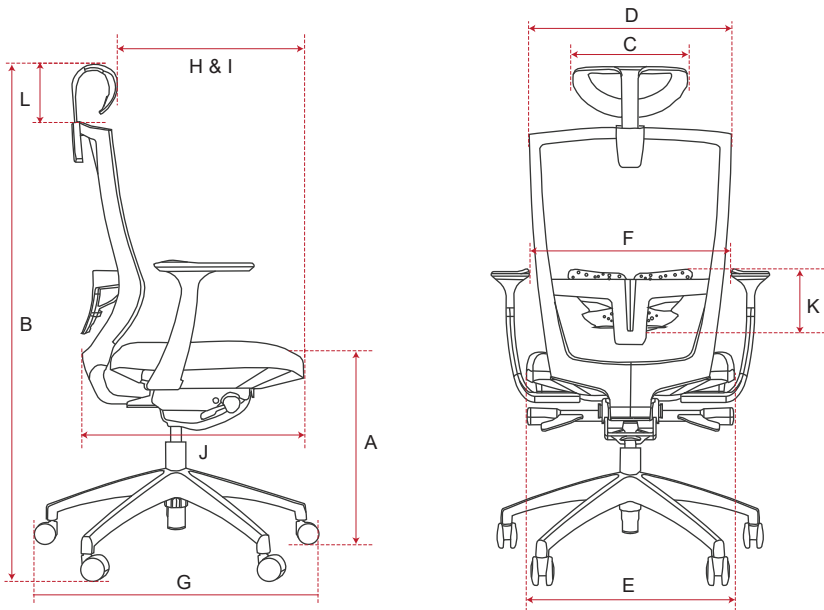

Code	Dimension (mm)	High Back	Mid Back	Remark
a	Seat height of Y mechanism	430 - 510		Y mechanism - Synchronized monolocking
	Seat height of T mechanism	460 - 540		
	Seat height of P mechanism	460 - 540		
b	Overall height of Y mechanism	1070 - 1150	930 - 1010	T mechanism - Self-weight adjustment with synchronized multilocking
	Overall height of T mechanism	1110 - 1190	970 - 1050	
	Overall height of P mechanism			
c	Headrest width	270	-	P mechanism - Seat depth adjustment with synchronized multilocking
d	Backrest width	470		
e	Seat width	510		
f	Distance between X armrests	500		X armrest - Xenic fixed armrest
	Distance between W armrests	470		
	Distance between M armrests	460		
g	Base width	730		W armrest - Xenic adjustable armrest
h	Seat depth	485		
i	Overall depth	530		M armrest - Mars adjustable armrest
j	Seat depth range	50		
k	Adjustable lumbar range	80		
l	Adjustable headrest range	50	-	

\* Variance ±5mm

Packaging Types	Container Sizes	20' GP	40' GP	40' HQ
Completely Knocked Down (CKD) 1 chair per carton (chair base packed separately)		± 216 chairs	± 448 chairs	± 512 chairs
Completely Built-Up (CBU) 2 chairs per carton		± 100 chairs	± 216 chairs	± 216 chairs

[www.artmatrix.com.my](http://www.artmatrix.com.my)



**ARTMATRIX TECHNOLOGY SDN BHD** 200501017101 (694144-X)  
**ARTMATRIX MANUFACTURING SDN BHD** 200501016616 (693659-U)  
Lot 32789, Jalan 5/1A, Taman Perindustrian Selesa Jaya,  
43300 Balakong, Selangor, Malaysia.  
☎ +603 8962 2286 📠 +603 8961 8862  
✉ [sales@artmatrix.com.my](mailto:sales@artmatrix.com.my) 🌐 [www.artmatrix.com.my](http://www.artmatrix.com.my)



MALAYSIA • SINGAPORE • THAILAND • MAURITIUS • INDIA • INDONESIA • PHILIPPINES • CAMBODIA • MYANMAR • SAUDI ARABIA

Accreditation



Green Labels and Awards



International Member of



Member of

