



CHATTY BOOTH

Acoustic Cubicle Room



CHATTY BOOTH

Acoustic Cubicle Room

With great acoustic property, Net@work is further redesigned into a more comprehensive system, the Chatty Booth. Its soundproof property offers a conducive space for making calls, video conferencing and private meetings without distraction, keeping your conversation private.

Chatty Booth is available in 3 models – CT-01 (phonebooth), CT-02 (two-seater discussion room) and CT-04 (multi-seater meeting room). This fully enclosed room is furnished with waterproof carpet flooring, lighting system, ventilation system and integrated wire management to create an exceptional working experience. With our privacy booth, collaboration and individual privacy can coexist in workplaces to nurture creative working communities with great ambition.

Chatty Booth incorporated with smart office system is also a hi-tech solution to make your booth more automated and convenience. Electrical fittings such as lights, fans, television, or motorized roller blind can be controlled using mobile apps, or an optional voice command speaker. It is a next-generation work hub that accommodates digital savvy employees to foster creativity and productivity.

26 NIC rating

Tested by TUV SUD PSB Singapore
Test Report No. 7191212028-MEC19-EMK





FRONT VIEW



LEFT SIDE VIEW



RIGHT SIDE VIEW



TOP VIEW

CHATTY BOOTH CT -01

More centralized communication and collaboration are among the top workplace trends nowadays, which encourage coworking space and open plan layout in offices. However, noises and distractions exist. CT-01 model tips the right balance by providing acoustic personal space for phone calls, video conferencing, and concentrated tasks in an open area. It is also equipped with a wooden desk to provide user with ample working space.



Fresh air blown in from the ventilation fans

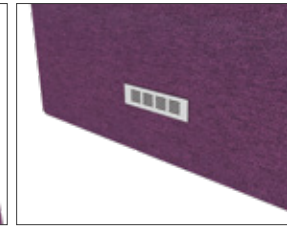

Hot air blown out from the ventilation holes



Wooden desk



USB port

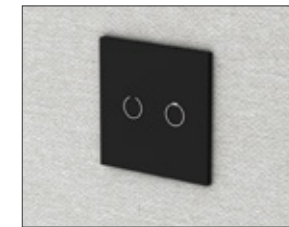

Touch switch

DIMENSION:

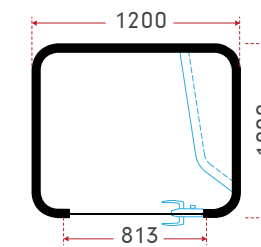

Top view

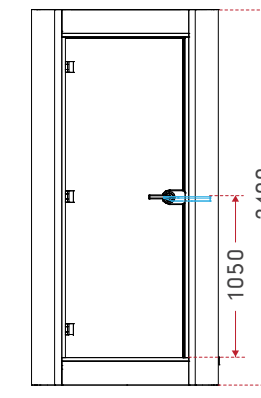

Front view

Minimum recommended ceiling height is 2700 mm from the floor for installation of Chatty Booth.



OPTIONAL:





CHATTY BOOTH CT -02

Private discussion, collaborative task and breakout session in open spaces are now possible with CT-02 model. It is a conducive space for face-to-face communication by eliminating possible interference from the surrounding, credits to its good acoustic properties. Optional table shapes are available for selection to suit user needs, or it can be transformed into a relaxation pod by introducing a sofa set.



FRONT VIEW



LEFT SIDE VIEW



RIGHT SIDE VIEW



TOP VIEW



Fresh air blown in from the ventilation fans

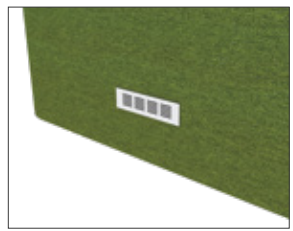

Hot air blown out from the ventilation holes



Wooden desk



USB port

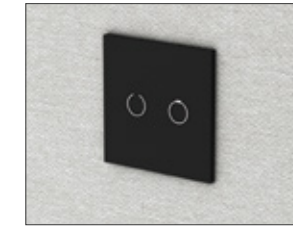

Touch Switch

OPTIONAL



Voice command speaker
*Vera Smart Office System

DIMENSION:

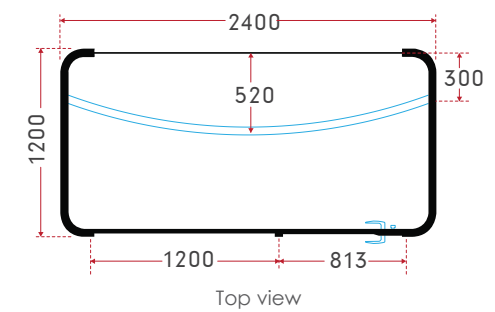

Top view

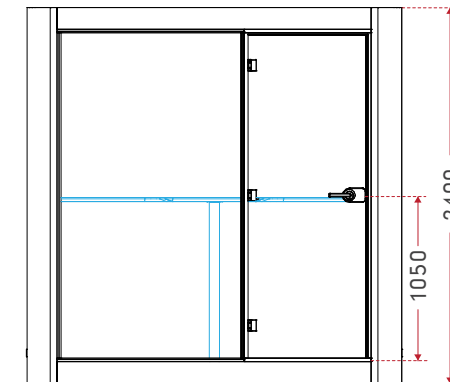

Front view

Minimum recommended ceiling height is 2700 mm from the floor for installation of Chatty Booth.

TABLE OPTIONS:

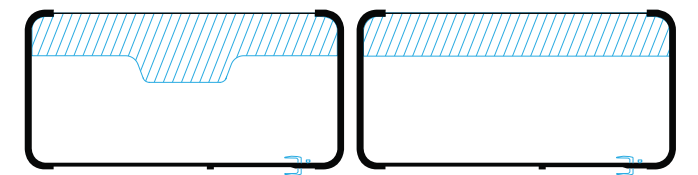

OPTIONAL:





FRONT VIEW

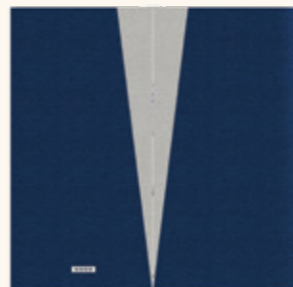

LEFT SIDE VIEW

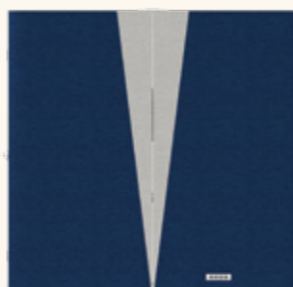

RIGHT SIDE VIEW



TOP VIEW

CHATTY BOOTH CT -04

Meeting room is now redefined with the introduction of CT-04 model. Without the need to renovate office interior, CT-04 model can be easily installed into office environment. The meeting room layout can be reconfigured to suit company style, working culture and user demand, giving a flexible solution for effective meeting. By restructuring meeting room layout with sofa sets, CT-04 can easily transform into a leisure area.



Fresh air blown in from the ventilation fans



Hot air flown out from the ventilation holes

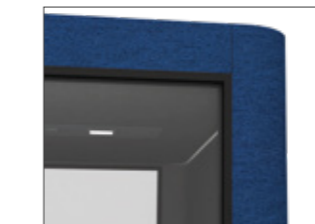

Black aluminium frame



USB port



Power outlet

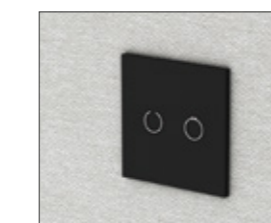

Touch Switch

OPTIONAL



Voice command speaker
*Vera Smart Office System

DIMENSION:

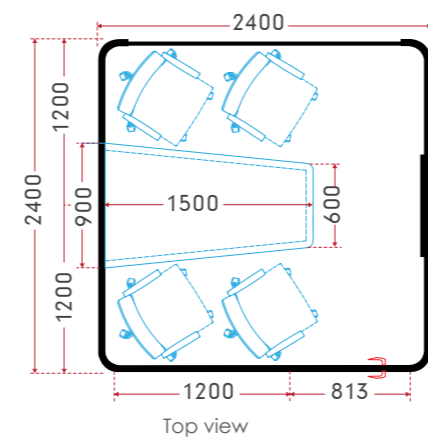

Top view

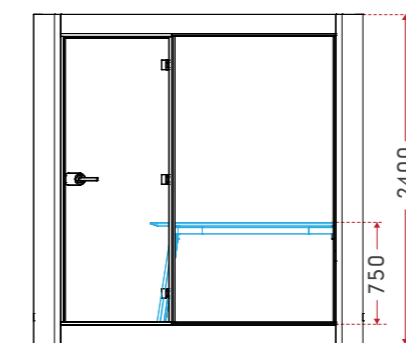

Front view

Minimum recommended ceiling height is 2700 mm from the floor for installation of Chatty Booth.

OPTIONAL:



WIRE MANAGEMENT

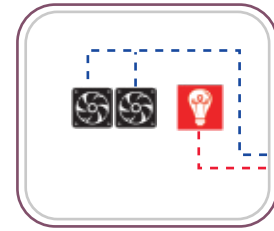

CT - 01

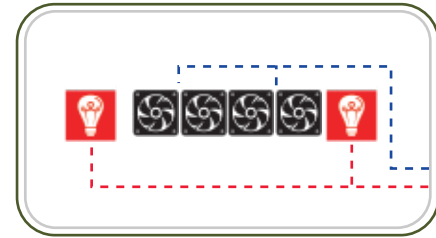

CT - 02

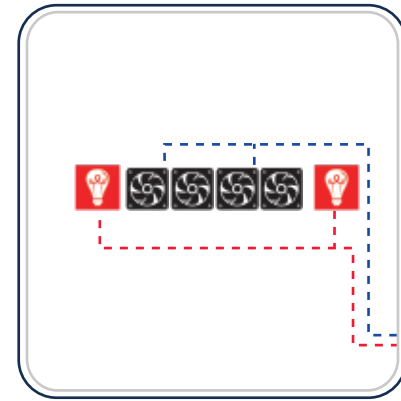

CT - 04

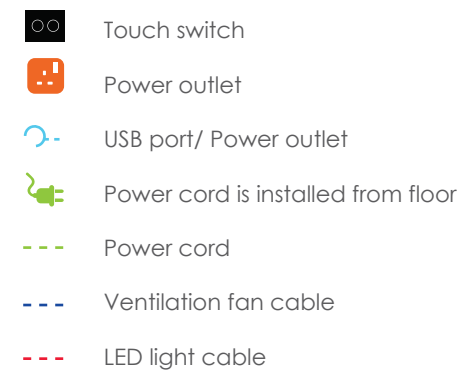
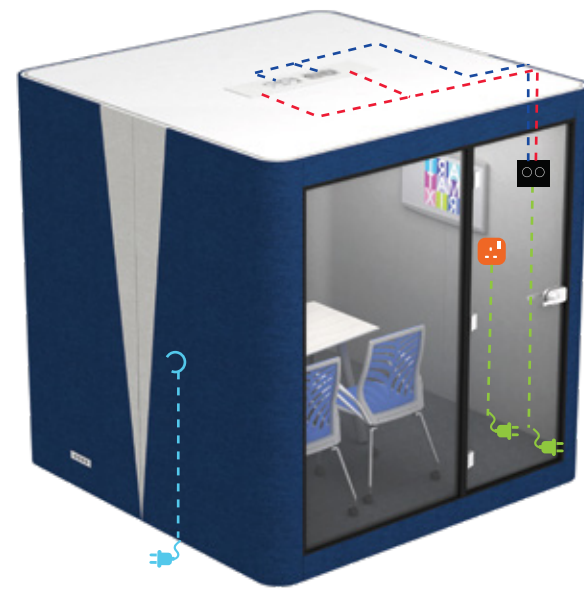
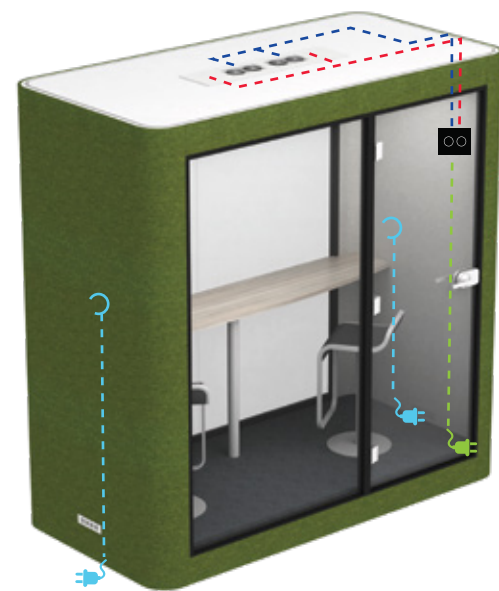
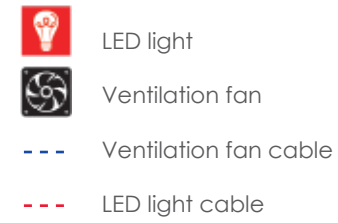

CHATTY BOOTH BASIC FEATURES



Fresh air blown in from the ventilation fans



Hot air flown out from the ventilation holes



Ventilation access & LED lighting for CT-01



Ventilation access & LED lighting for CT-02 and CT-04

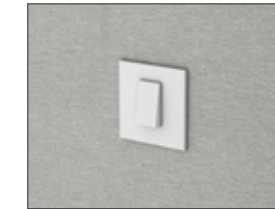

Flip switch



Right and left handed door handle



Tempered glass



Waterproof carpet flooring

CHATTY BOOTH ADDITIONAL FEATURES

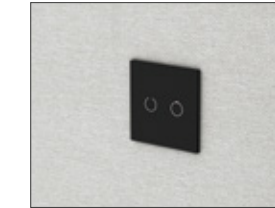

Touch switch



USB port



Power outlet



Voice command speaker
*Vera Smart Office System



Glass writing board

COLOR SELECTION

EXTERIOR AND INTERIOR FABRIC COLOUR



A-101RE



A-110PU



A-112BR



A-116GR



A-104GR



A-102WH



A-105WH



A-100GY



A-108GY

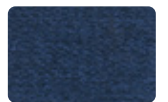

A-117BL

WORKTOP COLOUR



Snow White



Murnau Maple



Rochelle White



Olive Ash



Pesca



Cherry



Marinus Walnut



Havana Oak



Walnut



Paradisa



Mahogany

STANDARD CARPET COLOUR



Stepway

Disclaimer:

1. Due to continuous research & development, the features of certain products may change.
2. Colour shown may not be an accurate representation of the actual colour, please refer to actual colour samples for final confirmation.



www.artmatrix.com.my

ARTMATRIX TECHNOLOGY SDN BHD (694144-X)
ARTMATRIX MANUFACTURING SDN BHD (693659-U)
 Lot 32789, Jalan 5/1A, Taman Perindustrian Selesa Jaya,
 43300 Balakong, Selangor, Malaysia.
 ☎ +603 8962 2286 📠 +603 8961 8862
 ✉ sales@artmatrix.com.my 🌐 www.artmatrix.com.my

KK SHOWROOM
 Ground Floor, Block B, Lot 4,
 Damai Plaza Phase 3,
 Wisma CTF, Jalan Damai,
 88300 Kota Kinabalu, Sabah, Malaysia.
 ☎ +6088 448 355 / 448 655 📠 +6088 448 455

Ergonomic Seatings • Open Plan System • Office Furniture • Space Concept • Design and Build

MALAYSIA • SINGAPORE • THAILAND • INDIA • INDONESIA • PHILIPPINES

Accreditation



ISO 9001 & ISO 14001 Certified

Green Labels and Awards



International Member of



Member of

